

## NEW OR UPGRADED ELECTRICAL SERVICE

The following steps summarize the general process and procedures necessary for CVEA to complete construction of a new or upgraded service. Variances may be necessary for individual requests, and the CVEA staking technician will communicate these as the process advances.

- Complete Form 421: New/Upgraded Electrical Service Request Form available at the Glennallen or Valdez CVEA office or online at [cvea.org](http://cvea.org). Your form will include:**



- Contact information for applicant/landowner/contractor
- Connected load
- Site plans
- Other utilities sharing the trench/structure
- Construction completion date

- A staking technician will contact you to discuss the project and schedule a site visit.**
- While we are designing and estimating your service, you should begin obtaining any necessary permits or material and arrange for land clearing/grading as needed.**
- Once the design is complete, CVEA will send you an approved cost estimate.**



Please return the signed cost estimate and any associated payments.

Loan applications are available through CVEA upon request.

- For most projects, CVEA will draft a Right of Way Easement and an Agreement to Extend for your notarized signatures.**



Both CVEA main offices have all documents available and a notary in-house for your convenience.

**After payment is received, all documents are in place, the project meets CVEA requirements for installation, and the meter base is installed and city approved (Valdez only), then your project is released to be installed. Date of completion is dependent on work load at the time of release.**

# CONTENTS

This packet is intended to assist applicants in the process of new or upgraded single phase service of 200 AMPs or less with Copper Valley Electric Association (CVEA). Each service request is unique and may require additional or alternative direction. Please contact the Staking Technician at 907-835-7025 or [peltier@cvea.org](mailto:peltier@cvea.org) to initiate the process.

- ❑ Right of Way Clearing Requirements..... 1
  - Overhead Construction
  - Underground Construction
  
- ❑ Underground Construction
  - Wiring Guide ..... 2
  - Material List ..... 3
  - Installation Guides
    - Meter Base Installed on Building ..... 4
    - Meter Installed on a Post..... 5
    - Temporary Power..... 6-7
  
- ❑ Overhead Construction
  - Wiring Guide ..... 8
  - Material List ..... 9
  - Installation Guide
    - Meter Base Installed on Building ..... 10
    - Meter Installed on a Pole..... 11

# RIGHT OF WAY CLEARING

The applicant must clear right of way per the guidelines below prior to the construction of any line extension.

## Overhead Construction

**WHAT TO CLEAR** – All trees, branches, shrubs, brush, or other obstacles within or hanging within 15' from the centerline of the CVEA-designed line and 30' from any pole with a guy. Stumps must be cut to ground level or removed.

**WHEN TO CLEAR** – Work Orders are not placed in the CVEA construction queue until the right of way has been cleared, meter base installed, and all paperwork is submitted to and approved by CVEA.

**UNAVOIDABLE OBSTACLES** – The customer must communicate all known unavoidable obstacles, such as septic systems, buried lines, or drainage systems, to CVEA prior to design.

**AFTER CONSTRUCTION** – Customer may reseed the right of way at risk of CVEA clearing all growth and obstructions in the future. No structures, driveways, or other obstacles may be installed within the right of way without written consent of CVEA. Under no circumstances may any person climb CVEA's poles or attachments. Nothing may be attached to the pole, such as dog leads, mail boxes, satellite dishes, etc.

## Underground Construction

**WHAT TO CLEAR** – All trees, branches, shrubs, brush, or other obstacles within or hanging within 10' from the centerline of the CVEA-designed line. Stumps must be cut within 1' of ground level or removed.

**WHEN TO CLEAR** – Work Orders are not placed in the CVEA construction queue until the right of way has been cleared, meter base installed, and all paperwork is submitted to and approved by CVEA.

**UNAVOIDABLE OBSTACLES** – The customer must communicate all known unavoidable obstacles, such as septic systems, buried lines, or drainage systems, to CVEA prior to design.

**AFTER CONSTRUCTION** – Customer may reseed the right of way at risk of CVEA clearing all growth and obstructions in the future. No permanent structures, driveways, or other obstacles may be installed within the right of way without written consent of CVEA.

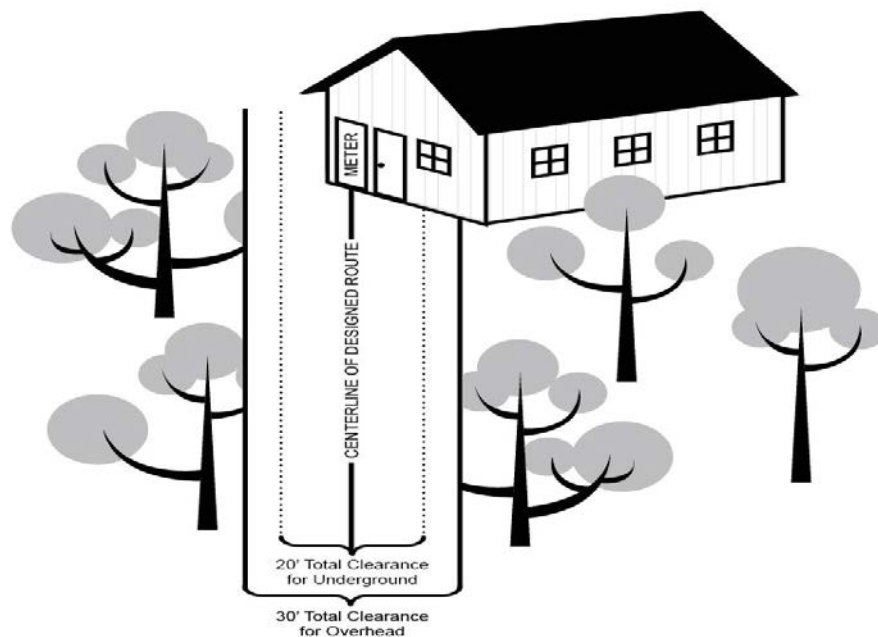

# WIRING GUIDE: Underground Service





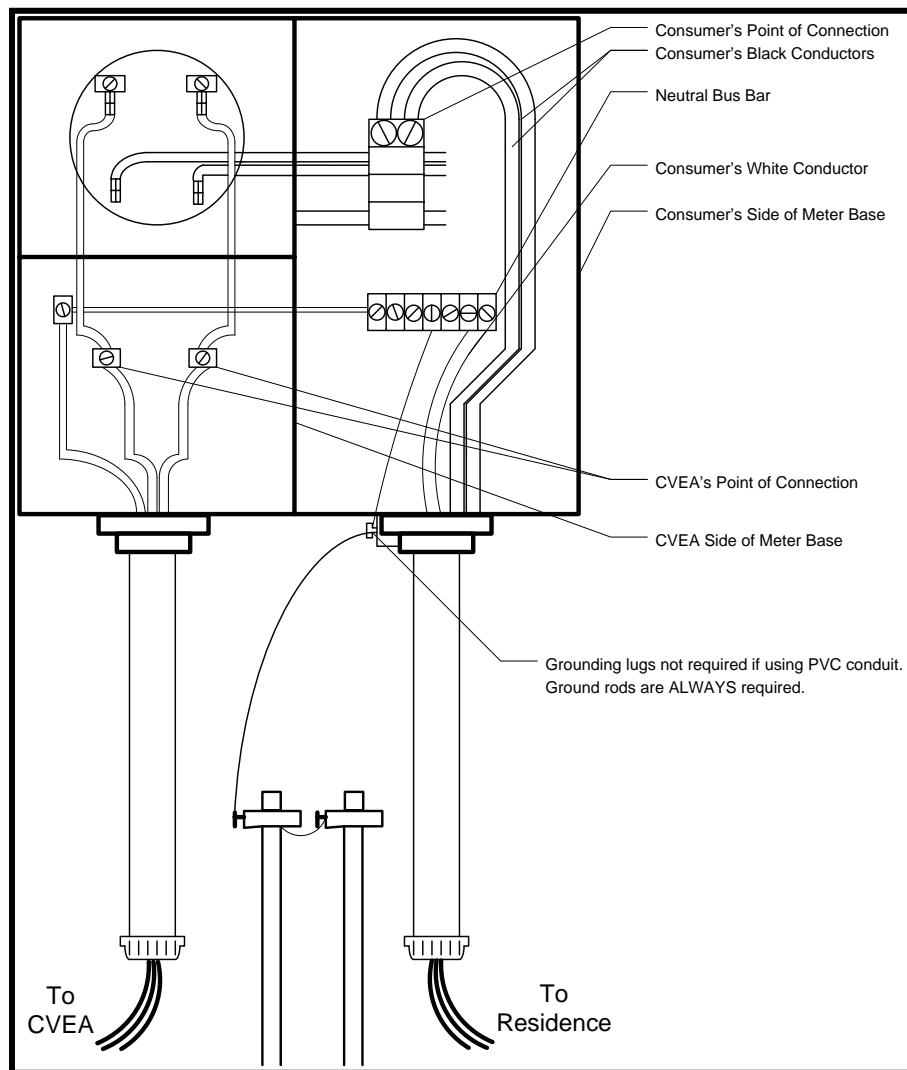

To install the conductors to the breaker switch in the meter base:

1. If using aluminum conductors, apply corrosion inhibitor to ends of wire prior to installation.
2. Take the 2 black conductors and place them in the breaker lugs, and tighten them down.
3. Take the white (or black-and-white striped) conductor and place it in the neutral bus bar, and tighten down the lug.
4. Insert the bare copper ground wire through the grounding lug on the consumer's side of the meter base. Run the ground wire through the knockout hole and into the neutral bus bar. (This must be done in one continuous run with no splices). Insert the other end of the ground wire into the ground rod clamp and connect it to the first ground rod. Run the ground wire to the second ground rod, and tighten down on the ground rod clamp. Remember to leave enough slack in the ground wire to staple it to the meter base pole. Tighten all grounding lugs and ground rod clamps.

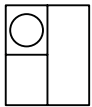
**Note:** If located in Valdez, the meter base shall be inspected by the City prior to CVEA's service installation.

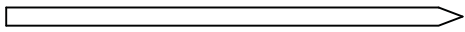
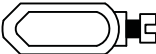

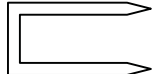
## Material List: Underground Services\*

Amount	Item	Description
1		UL Approved Meter Base with Main Breaker and Accommodates Underground Service Feed
1		2" PVC Terminal Male Adaptor
1		Locknut for 2" Conduit
2		5/8" x 8' Copper Clad Steel Ground Rod
2		Ground Rod Clamp
20'		#4 Bare Solid Copper Ground Wire
~20		Ground Wire Staples
1		Tube of Corrosion Inhibitor

\*provided as a customer aid and may not include all necessary materials

# INSTALLATION GUIDE: Underground to Building

**Note:** It may be preferable to assemble the meter base on the ground, then attach it to the structure.

## To Install the Conductors to the Meter Base Lugs:

1. Remove the meter base from the box it came in, and place it on the ground.
2. Remove the 2" riser knockout on the bottom of the meter base. Remove the one small knockout on the bottom right side (consumer's side) of the meter base (this is for the ground wire installation).
3. Insert the male adapter into the knockout hole, and tighten it down with the 2" lock nut. Install the consumer's facilities exiting the meter base.
4. Install the breaker switch into the breaker bus bar. See wiring diagram for positioning.
5. Install the assembled meter base to the house with lag screws.
6. Secure the conduit to the house with the 2" conduit clamps and lag screws.

**Note:** You may need to install a commercially treated wood spacer between the back of the riser and the house. Add them as necessary.

7. Install the ground rods 6' away from each other and 2' away from any structures, and attach the ground rod clamps and ground wire to them (see wiring diagram).

**Note:** The consumer's conductors may be run in after the CVEA service is installed. Services in Valdez shall be City inspected prior to CVEA service installation.

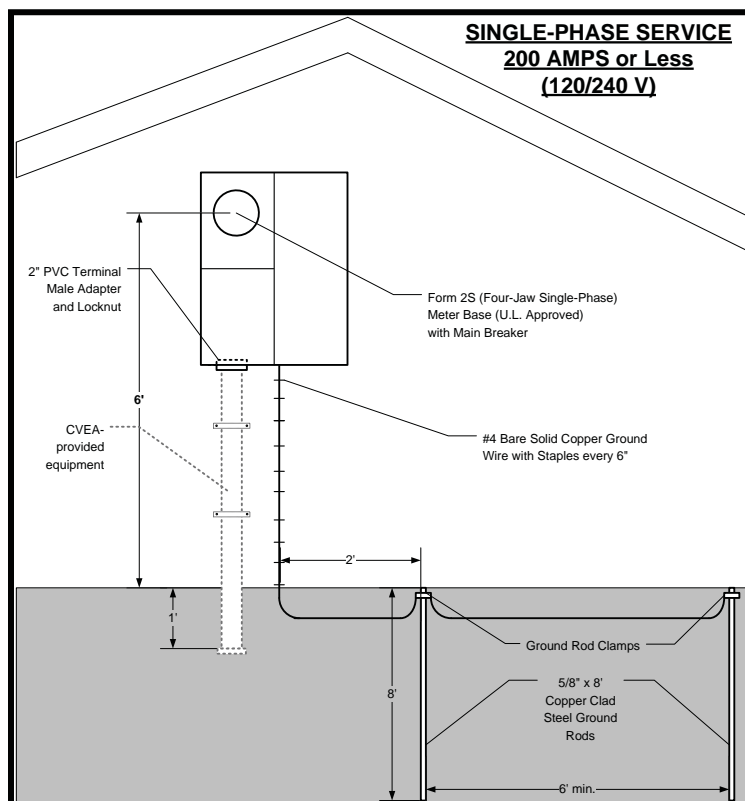

# INSTALLATION GUIDE: Meter on Post

**Note:** It may be preferable to assemble the meter base on the ground, then attach it to the meter post.

1. Remove the two 2" riser knockouts on the bottom of the meter base. Remove the one small knockout on the bottom right side (consumer's side) of the meter base. (This is for the ground wire installation.)
2. Insert the male adapter into the knockout hole, and tighten it down with the 2" lock nut. Install the consumer's facilities exiting the meter base.
3. See the wiring diagram for underground service to complete the meter base wiring.
4. Secure the commercially treated plywood to the commercially treated 4" x 6" x 10' post with lag screws.
5. Install the assembled meter base on the commercially treated plywood with lag screws.
6. Fasten the risers to the meter pole by using the 2" conduit clamps and lag screws.

**Note:** You may need to install a commercially treated wood spacer between the back of the riser and the 4" x 6" x 10'. Add them as necessary.

7. Install the ground rods 6' away from each other and 2' away from any structures, and attach the ground rod clamps and ground wire to them (see wiring diagram).

**Note:** The consumer's conductors may be run in after the CVEA service is installed. Services in Valdez shall be inspected by the City prior to CVEA service installation.

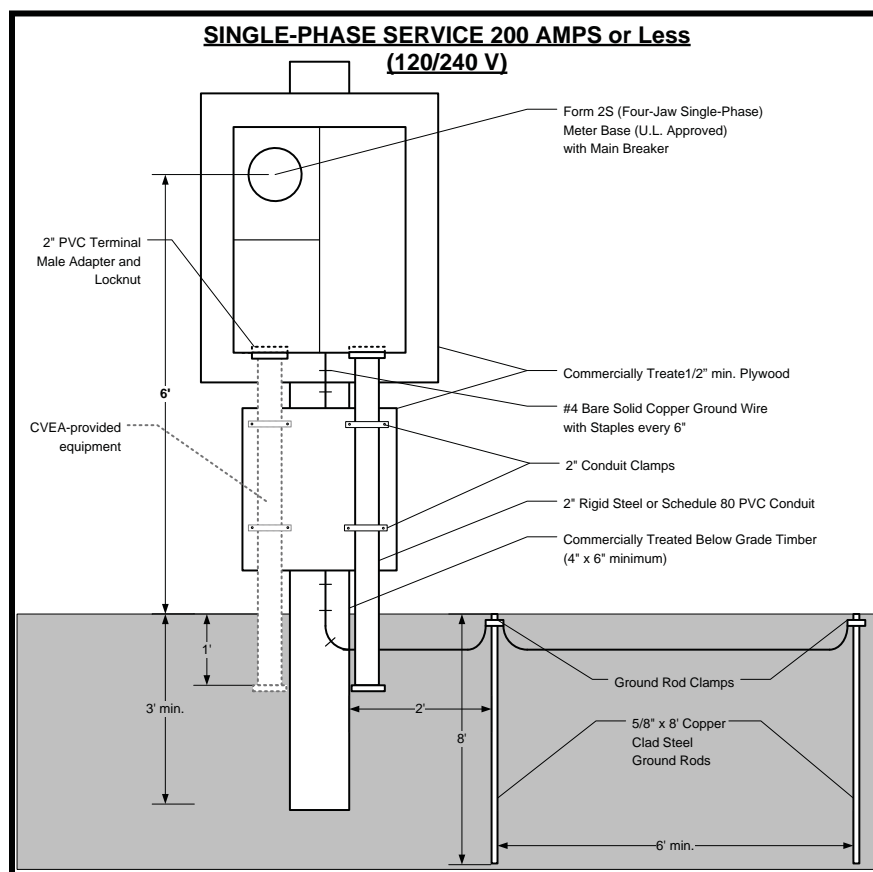

# INSTALLATION GUIDE: Temporary Pedestal

**Note:** It may be preferable to assemble the meter base on the ground, then attach it to the meter pole.

1. Remove the two 2" riser knockouts on the bottom of the meter base. Remove the one small knockout on the bottom right side (consumer's side) of the meter base. (This is for the ground wire installation.)
2. Insert the male adapter into the knockout hole, and tighten it down with the 2" lock nut. Install the consumer's facilities exiting the meter base.
3. See the wiring diagram to complete the meter base wiring.
4. Secure the commercially treated plywood to the commercially treated 4" x 6" x 10' post with lag screws.
5. Install the assembled meter base on the commercially treated plywood with lag screws.
6. Fasten the risers to the meter pole by using the 2" conduit clamps and lag screws.

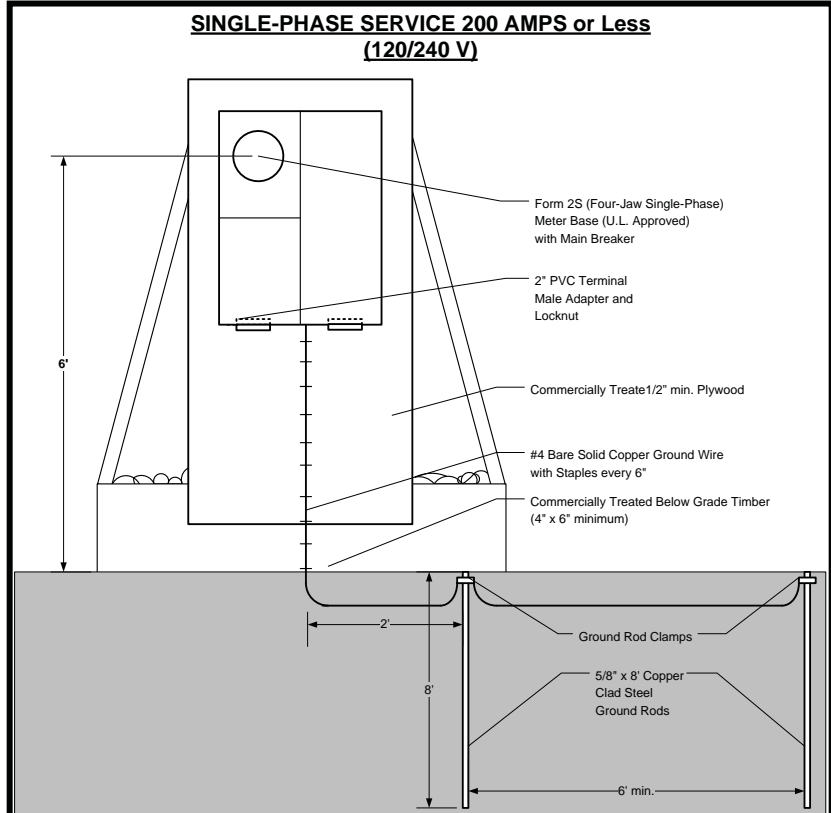

**Note:** You may need to install a commercially treated wood spacer between the back of the riser and the 4" x 6" x 10'. Add them as necessary.

7. Install the ground rods 6' away from each other and 2' away from any structures, and attach the ground rod clamps and ground wire to them (see wiring diagram).

**Note:** The consumer's conductors may be run in after the CVEA service is installed. Services in Valdez shall be inspected by the City prior to CVEA service installation.

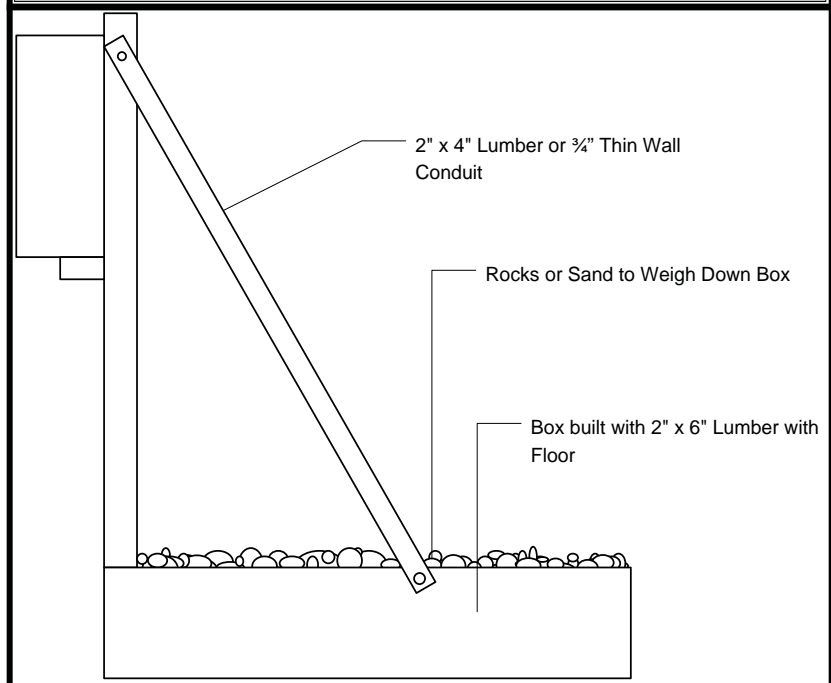



# INSTALLATION GUIDE: Temporary Post

**Note:** It may be preferable to assemble the meter base on the ground, then attach it to the meter post.

1. Remove the two 2" riser knockouts on the bottom of the meter base. Remove the one small knockout on the bottom right side (consumer's side) of the meter base. (This is for the ground wire installation.)
2. Insert the male adapter into the knockout hole, and tighten it down with the 2" lock nut. Install the consumer's facilities exiting the meter base.
3. See the wiring diagram to complete the meter base wiring.
4. Secure the commercially treated plywood to the commercially treated 4" x 6" x 10' post with lag screws.
5. Install the assembled meter base on the commercially treated plywood with lag screws.
6. Fasten the risers to the meter pole by using the 2" conduit clamps and lag screws.







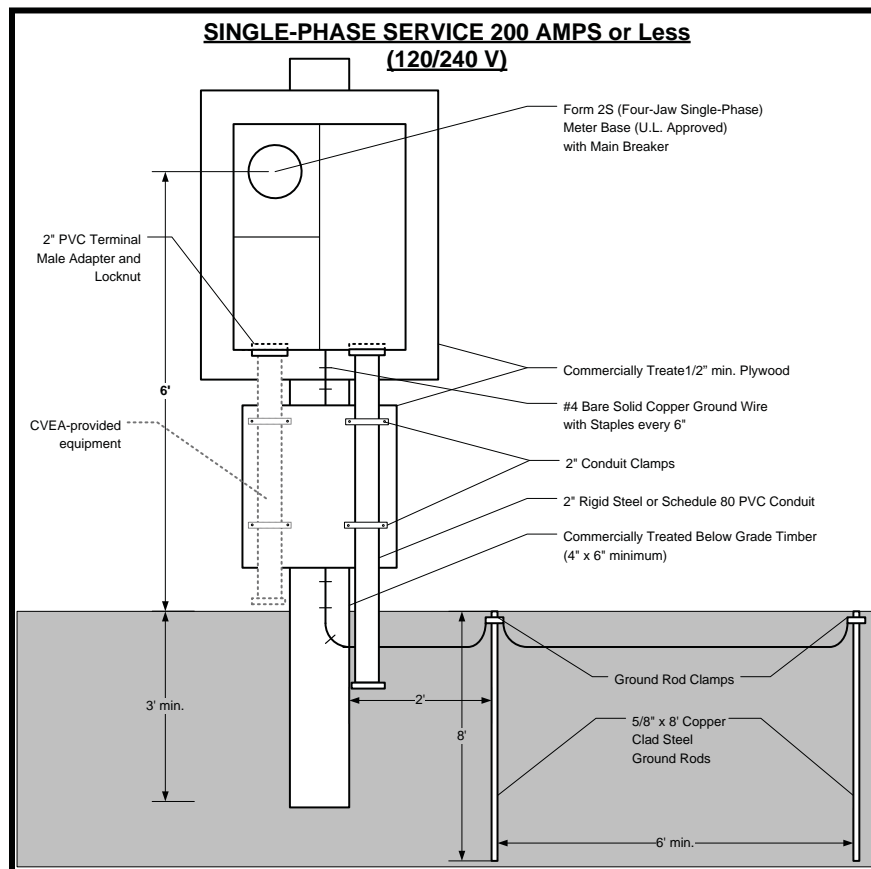

**Note:** You may need to install a commercially treated wood spacer between the back of the riser and the 4" x 6" x 10'. Add them as necessary.

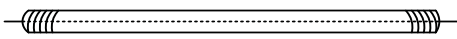
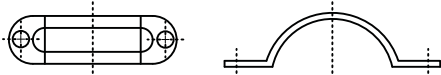
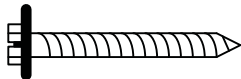
7. Install the ground rods 6' away from each other and 2' away from any structures, and attach the ground rod clamps and ground wire to them (see wiring diagram).

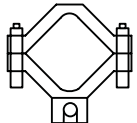
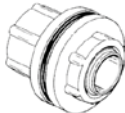
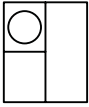
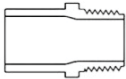
**Note:** The consumer's conductors may be run in after the CVEA service is installed. Services in Valdez shall be inspected by the City prior to CVEA service installation.

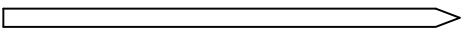
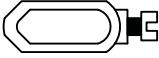

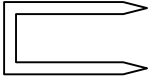
## Material List: Overhead Services\*

Amount	Item	Description
1		Weatherhead for 2" galvanized rigid steel
10'		10' of 2" rigid steel galvanized
4		2" Conduit Clamps
11		Lag Screw for conduit clamps / meter base
20'		14' URD Triplex Conductor
1		Conduit Ground Bonding Clamp
1		Rain-Tight Hub for 2" Conduit
1		UL Approved Meter Base with Main Breaker and Accommodates Underground Service Feed
1		2" PVC Terminal Male Adaptor
1		Locknut for 2" Conduit
2		5/8" x 8' Copper Clad Steel Ground Rod
2		Ground Rod Clamp
20'		#4 Bare Solid Copper Ground Wire
~20		Ground Wire Staples
1		Tube of Corrosion Inhibitor

\*provided as a customer aid and may not include all necessary materials

# WIRING GUIDE: Overhead Service

To install the conductors to the meter base lugs:

1. Run the three conductors down the riser into the meter base.
2. Cut and remove the polyethylene conductor coating back 1" from the ends of the three conductors.
3. Apply a coating of corrosion inhibitor to all bare aluminum conductors.
4. Take the black conductors and place them into the meter base lugs and tighten down.
5. Take the white (or black with white stripe) conductor and place it in the neutral bus bar and tighten down.

**Note:** Install the weatherhead on top of the riser after the conductors have been installed in the riser and the meter base. Conductors to be installed into the meter base by consumer.

To install the conductors to the breaker switch in the consumer's side of the meter base:

1. Cut and remove the polyethylene conductor coating back 1" from the ends of the three conductors.
2. Apply a coating of corrosion inhibitor to all bare aluminum conductors.
3. Take the 2 black conductors and place them in the breaker lugs, and tighten them down.
4. Take the white conductor and place it in the neutral bus bar and tighten down the lug. This step is to be done after the meter base is installed on the meter pole.
5. Insert the bare copper ground wire through the grounding lug on the consumer's side of the meter base. Run the ground wire through the knockout hole and into the neutral bus bar. (This must be done in one continuous run with no splices). Insert the other end of the ground wire into the ground rod clamp and connect it to the first ground rod. Run the ground wire to the second ground rod and tighten down on the ground rod clamp. Remember to leave enough slack in the ground wire to staple it to the meter base pole. Tighten all grounding lugs and ground rod clamps.

**Note:** The consumer's conductors may be installed after the CVEA service is installed.

**Note:** Services in Valdez must be approved by the City inspector prior to CVEA's service installation.

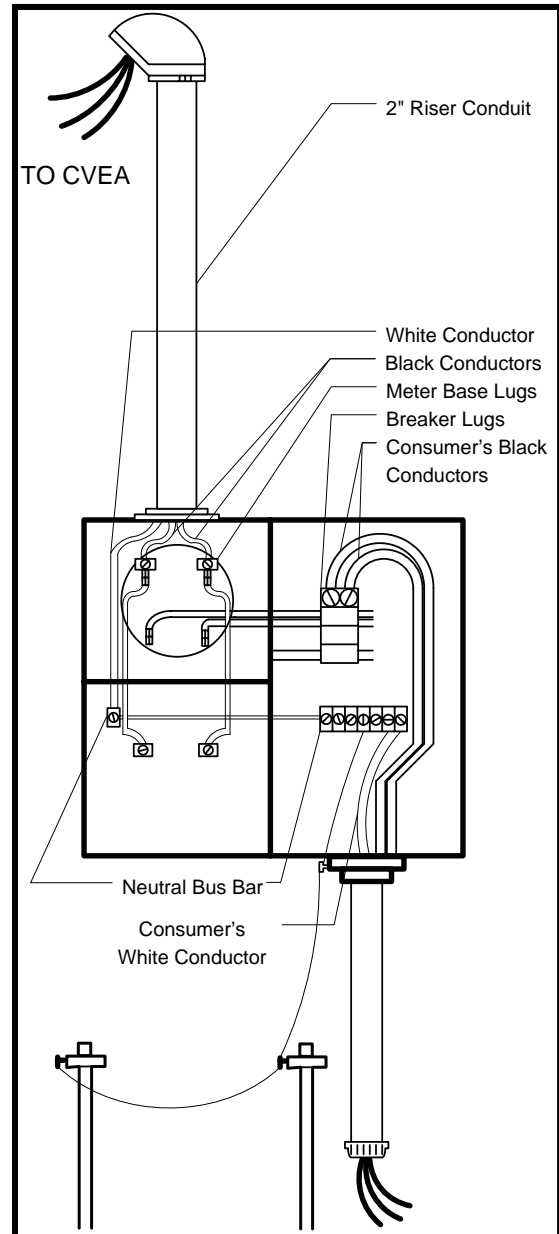

# INSTALLATION GUIDE: Overhead to Building

1. Remove the knockout on the top left hand side and the small knockout on the bottom right side of the meter base (see wiring diagram).
2. Place the rain-tight hub for 2" conduit over the top knockout hole and secure it with the four screws provided.
3. Thread the riser into the rain-tight bug and tighten to a snug fit.
4. Snap the breaker switch into the breaker bus bar, see wiring diagram for positioning.
5. Complete the meter base wiring as per the meter base wiring diagram.
6. Install the weatherhead on top of the riser by inserting the conductors through the holes on the inside of the weatherhead, then sliding the weatherhead on top of the conduit riser. Tighten down the clamp on the weatherhead to secure.
7. Install the assembled meter base to the house with lag screws.
8. Secure the conduit riser to the house with 2" conduit clamps with the spacer between conduit and house to assure a snug fit.
9. Install the ground rods, both must be at least 2' from the edge of the building and separated by no less than 6'. Connect ground wire per wiring diagram.

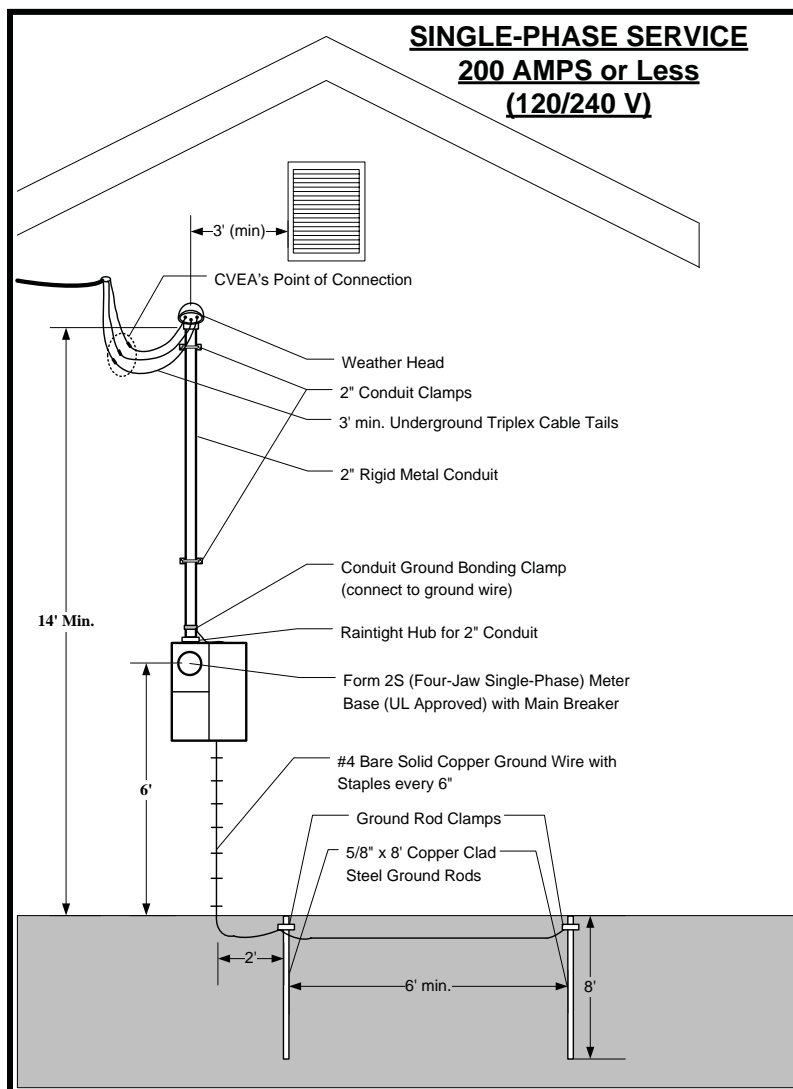

# INSTALLATION GUIDE: Meter on Pole

1. Remove the knockout on the top left hand side and the small knockout on the bottom right side of the meter base (see wiring diagram).
2. Place the rain-tight hub for 2" conduit over the top knockout hole and secure it with the four screws provided with the hub.
3. Thread the riser into the rain-tight hub and tighten to a snug fit.
4. Install the breaker switch into the breaker bus bar (see wiring diagram).
5. Complete the meter base wiring as per the meter base wiring diagram.
6. Install the weatherhead on top of the riser by inserting the conductors through the holes on the inside of the weatherhead, then sliding the weatherhead on top of the conduit riser. Tighten down the clamp on the weatherhead to secure.
7. CVEA will install the pole and attached the assembled meter base.
8. CVEA will assemble install the grounding assembly; provided customer.

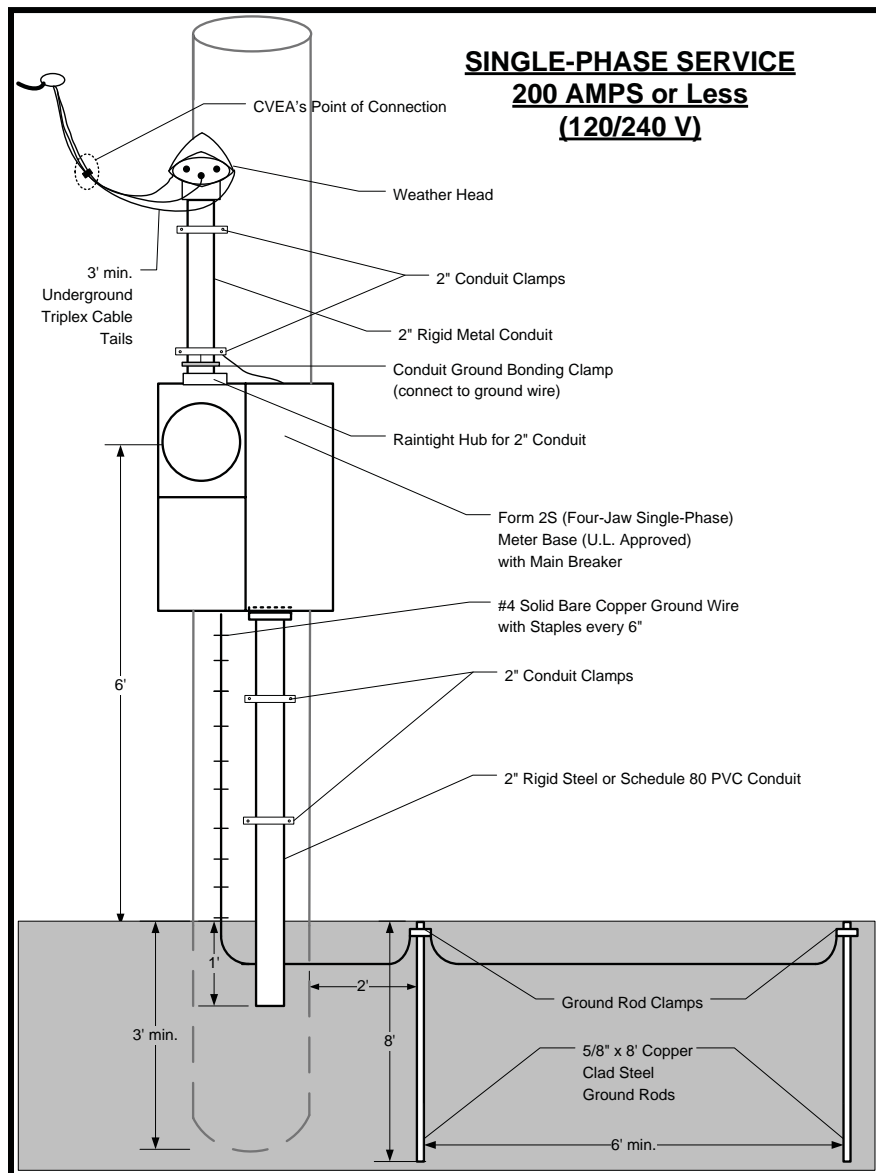

and  
material  
by